



MEGASENSOR

PRODUTOS EM FOCO



Série MS-Qxxx (versões)



Série MS - Qxxx

MEGA SP Comércio de Sensor Eireli – ME
Endereço: Rua Liliental, 247 – Bairro Pq. Edu Chaves
CEP 02231-000 – São Paulo – SP – Brasil
Telefone: 11-3938-5313 – Mobile/WhatsApp: 11-97162-7722
E-mail: vendas@megasensor.com.br



MEGASENSOR

PRODUTOS EM FOCO



Série MS - rotativos



Série MS-KHE

MEGA SP Comércio de Sensor Eireli – ME
Endereço: Rua Liliental, 247 – Bairro Pq. Edu Chaves
CEP 02231-000 – São Paulo – SP – Brasil
Telefone: 11-3938-5313 – Mobile/WhatsApp: 11-97162-7722
E-mail: vendas@megasensor.com.br



MEGASENSOR

PRODUTOS EM FOCO



Série MS - LFH



Série MS-XPE

MEGA SP Comércio de Sensor Eireli – ME
Endereço: Rua Liliental, 247 – Bairro Pq. Edu Chaves
CEP 02231-000 – São Paulo – SP – Brasil
Telefone: 11-3938-5313 – Mobile/WhatsApp: 11-97162-7722
E-mail: vendas@megasensor.com.br



MEGASENSOR

PRODUTOS EM FOCO



Série MS - XME



Série MS - S125 - MLR - veículos

MEGA SP Comércio de Sensor Eireli – ME
Endereço: Rua Liliental, 247 – Bairro Pq. Edu Chaves
CEP 02231-000 – São Paulo – SP – Brasil
Telefone: 11-3938-5313 – Mobile/WhatsApp: 11-97162-7722
E-mail: vendas@megasensor.com.br



MEGASENSOR

PRODUTOS EM FOCO



Série MS - SKM-PLR - veículos



Série MS - SKT-LBM - veículos

MEGA SP Comércio de Sensor Eireli – ME
Endereço: Rua Liliental, 247 – Bairro Pq. Edu Chaves
CEP 02231-000 – São Paulo – SP – Brasil
Telefone: 11-3938-5313 – Mobile/WhatsApp: 11-97162-7722
E-mail: vendas@megasensor.com.br



MEGASENSOR

PRODUTOS EM FOCO



Série MS - S125 LR

MEGA SP Comércio de Sensor Eireli – ME
Endereço: Rua Liliental, 247 – Bairro Pq. Edu Chaves
CEP 02231-000 – São Paulo – SP – Brasil
Telefone: 11-3938-5313 – Mobile/WhatsApp: 11-97162-7722
E-mail: vendas@megasensor.com.br



MEGASENSOR

PRODUTOS EM FOCO

Rotating Beacons

SK series

LED life
100.000
hours*1

IP23

IP65*2

Sound
Pressure
88dB

Rotating
(120rpm)

Video of
light patterns:



SKS: Φ 80mm

SKH: Φ 100mm

SKP: Φ 150mm



R : Red



Y : Amber



G : Green



B : Blue

*1 Manufacturer specified value

*2 When used with rubber-gasket (Sold Separately)

Este modelo substitui a Série RLR (descontinuada)

Alta intensidade luminosa: acima de 65cd

Sonoro com 88dB

Vida útil acima de 100.000 horas

Rotativo

Motor sem atrito com vida útil acima de 20.000 horas

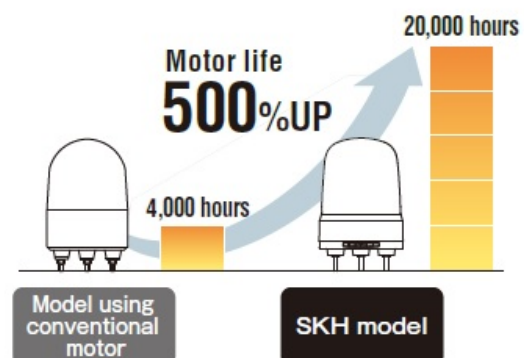
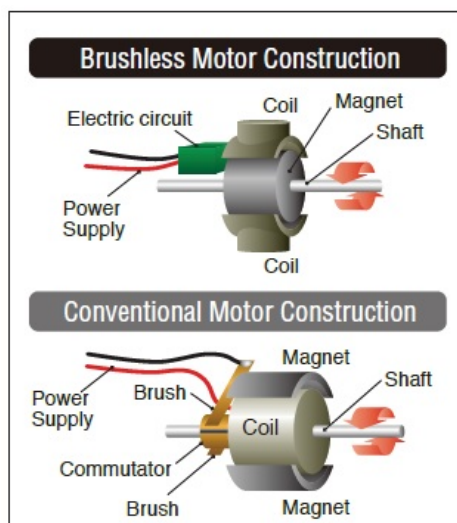

MEGA SP Comércio de Sensor Eireli – ME
Endereço: Rua Liliental, 247 – Bairro Pq. Edu Chaves
CEP 02231-000 – São Paulo – SP – Brasil
Telefone: 11-3938-5313 – Mobile/WhatsApp: 11-97162-7722
E-mail: vendas@megasensor.com.br



MEGASENSOR

PRODUTOS EM FOCO

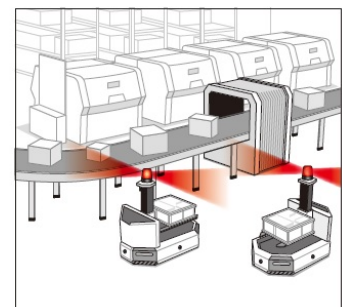
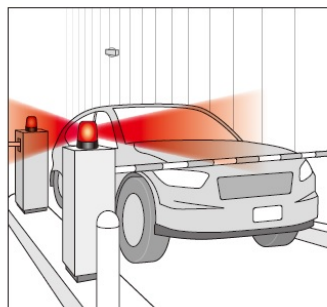
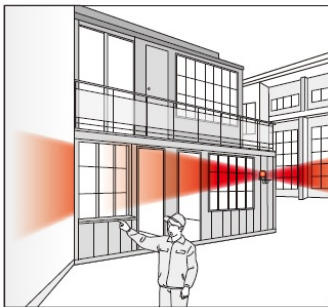
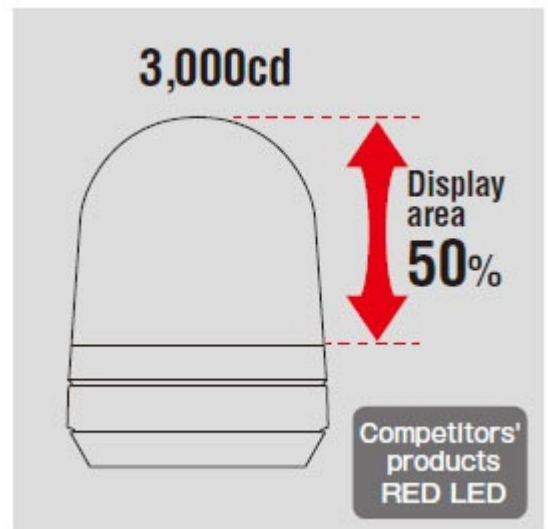
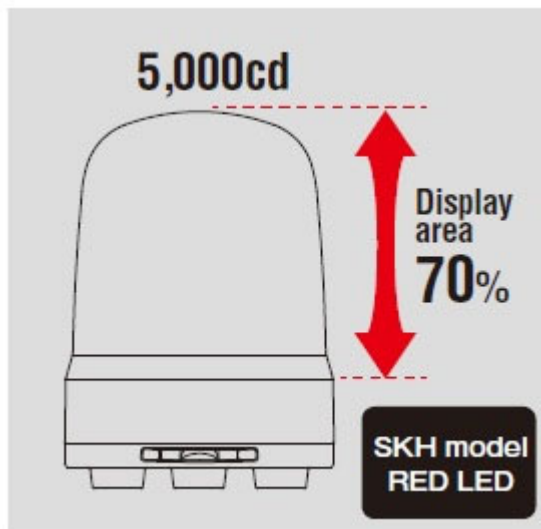
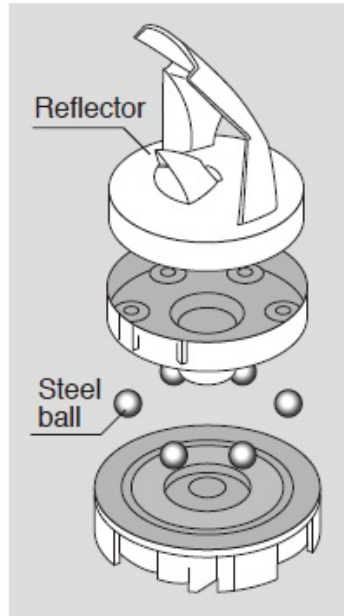

MEGA SP Comércio de Sensor Eireli – ME
Endereço: Rua Liliental, 247 – Bairro Pq. Edu Chaves
CEP 02231-000 – São Paulo – SP – Brasil
Telefone: 11-3938-5313 – Mobile/WhatsApp: 11-97162-7722
E-mail: vendas@megasensor.com.br



MEGASENSOR

PRODUTOS EM FOCO

Evolução dos Sinaleiros

PATLITE Beacons



MEGA SP Comércio de Sensor Eireli – ME
Endereço: Rua Liliental, 247 – Bairro Pq. Edu Chaves
CEP 02231-000 – São Paulo – SP – Brasil
Telefone: 11-3938-5313 – Mobile/WhatsApp: 11-97162-7722
E-mail: vendas@megasensor.com.br



MEGASENSOR

PRODUTOS EM FOCO

Novo conceito em sinaleiros LED

Vida útil estimada em 100.000 horas
Intensidade luminosa 5 x mais! Acima de 65cd
12/24Vdc
127/240 Vac

IP 23 (padrão) opcional IP 65 (com anel vedação)
opcional IP 66 (versão KT)

Flashing Beacons

SL series

LED life 100.000 hours*1

Cable Type: IP23, IP65*2

Screwless Terminal Type: IP66, KT type

Sound Pressure: 88dB, SLO8: 80dB

Light Patterns: Continuous, Blinking, Triple-flash

Video of light patterns: [QR Code]

R : Red, Y : Amber, G : Green, B : Blue

SL08: Φ 80mm, SL10: Φ 100mm, SL15: Φ 150mm

*1 Manufacturer specified value
*2 When used with rubber-gasket (Sold Separately)

MEGA SP Comércio de Sensor Eireli – ME
Endereço: Rua Liliental, 247 – Bairro Pq. Edu Chaves
CEP 02231-000 – São Paulo – SP – Brasil
Telefone: 11-3938-5313 – Mobile/WhatsApp: 11-97162-7722
E-mail: vendas@megasensor.com.br



MEGASENSOR

PRODUTOS EM FOCO

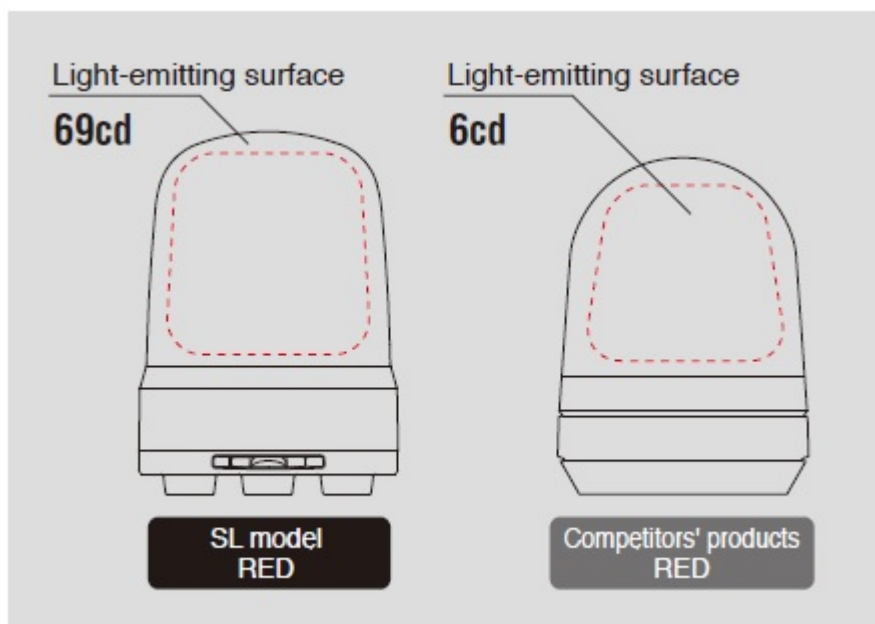

**Tecnologia Fresnel = lentes finas, maior distribuição da luz,
visibilidade longa distância**

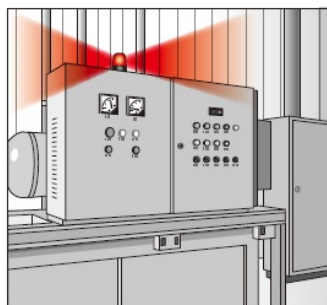
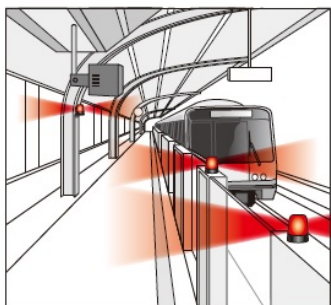

www.patlite.com

www.qlight.com

MEGA SP Comércio de Sensor Eireli – ME
Endereço: Rua Liliental, 247 – Bairro Pq. Edu Chaves
CEP 02231-000 – São Paulo – SP – Brasil
Telefone: 11-3938-5313 – Mobile/WhatsApp: 11-97162-7722
E-mail: vendas@megasensor.com.br